

ACQUISITION CHECKLIST / TIMELINE

Property Address: <u>1 ROLPH PARK DRIVE</u>	APN <u>354-203-002</u>
Owner's Name: <u>CARRIAGE SERVICES INC.</u>	Phone Number: <u>713-332-8452</u>
Fund Source: <u>Loan – lender tbd</u>	Reason for Acquisition: <u>District and Sanitary use</u>

Timeline	Task	Done	Comments
I.	Sept 25 Council/Agency authorization to: A) enter into negotiations, B) proceed with appraisal; and C) appropriate funds for appraisal	9/25/19	CVSan funds appropriated, determine split between depts. later
II.	Sept/Oct Order appraisal	10/3/19	
III.	Nov Notify owner of appraisal	11/18/19	Yes, didn't provide
IV.	Nov Determine if there are tenants.	n/a	Tenants vacated
V.	Dec 18 Board authorization to offer (based on appraisal)	12/18/19	\$725,000
VI.	Dec/Jan Offer to purchase contingent upon environmental	1/3/20	
VII.	Jan/Feb Order PTR / Condition of Title	2/7/20	Old Republic Title
VIII.	Feb Environmental assessment	2/21/20	Synergy Envir.
IX.	Feb CEQA analysis completed by staff	2/23/20	
X.	Feb Identify and select funding source	2/19/20	MFC or iBank
XI.	Feb Advise B&F of pending purchase, purchase amount, anticipated closing and source of funds		Appropriate funds
XII.	Feb 3,12,19 Commission agenda items with feedback at public meetings	Feb 3,19,24	
XIII.	Feb Prepare Agenda Report and forward to Board	2/24/20	
XIV.	Feb 26 Board authorization to purchase & issue Neg Dec		*tabled
	Feb 27 File CEQA Notice of Exemption with County		*tabled
XV.	Feb Received PTR	2/20/20	
XVI.	Feb District Attorney to review PTR	2/24/20	
	May Receive environmental assessments	5/20/20	Lead/Asbes/Termit
	May/June Finalize Purchase Agreement with owner		
XVII.	June 24 Authorize execution of purchase agreement		
	June 27 Execute financing loan documents		
XVIII.			Open escrow
XIX.			Confirm square footage (if necessary)
XX.			Feasibility review – object to exceptions in PTR
XXI.	July 22 Certificate of acceptance (prepare & Clerk sign)		Board Resolution
XXII.			Wire instructions from escrow
XXIII.			Closing Statement (review and have GM sign)
XXIV.			Coordinate wire of funds with Finance, prepare warrant request
XXV.			Receipt of title insurance policy
XXVI.			Receipt of conformed deed
XXVII.			Enter into Board property database
XXVIII.			Town meeting / outreach to announce purchase



CA Lic. #919541

Northern California
3458 Mt Diablo Blvd
Lafayette, CA 94549

Southern California
238 Glider Circle
Corona, CA 92882

PHONE: 925.299.0518
FAX: 925.299.0517
www.psrc.com

April 7, 2020

Re: Crockett Mortuary :

We are pleased to quote the following work of deck, roof and drywall replacement.

Scope of work:

1. Roof walk on deck:
 - a. Demo of existing 12x34 roof deck and railings. Remove all drywall to expose framing to inspect for damage.
 - b. Install blocking needed for plywood install.
 - c. Install new ALX class A fire rated decking. Build and waterproof standoffs to accept railings.
 - d. Install new metal segmented railings.
 - e. Repair drywall in garage area and finish to level 3. Leave ready for paint.

Total for work described above: \$23,387.00

2. Middle roof over embalming room:
 - a. Remove equipment and frame in one area where unit will not be reinstalled.
 - b. Demo full area and lift two remaining units for roofing to be replaced.
 - c. Install new base sheet, ply sheet, and surface sheet.
 - d. Repair drywall ceiling in embalming room and match texture. Leave paint ready.

Total for work described above: \$9,740.00

3. Large room with gravel roof.
 - a. Demo gravel roof and replace with Gaf base sheet, ply sheet, and surface sheet.
 - b. Repair drywall and leave ready for texture.

Total for described work above: \$14,520.00

Insurance cost 1.5% \$714.00

Total for all work above \$48,361.00

Exclusions:

1. Permits
2. Any dry rot damage to framing members exposed upon demolition.
3. Ceiling texture in room with gravel roof excluded until we know if acoustical texture has asbestos. Dale has had it tested but results are not yet known.

If you have any questions, please do not hesitate to contact me.

Sincerely,

Scot Doolittle

PSR West Coast Builders, Inc.

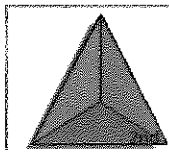

Environmental Science Services

AIHA Laboratory ID # 232274

February 26, 2020

Sal Vaccaro
Synergy Environmental
28436 Satellite St.
Hayward, CA 94545

RE: Limited Asbestos Survey for:
1 Ralph Park Drive
Crocket, CA
ESS PROJECT # 20201085-1

Environmental Science Services performed a limited asbestos survey of suspect asbestos containing materials (ACBM) at the above referenced site on 02/21/20 for building materials identification.

Bulk Sampling Report

Materials suspected of containing asbestos that were identified and sampled include,

- **LINOLEUM**
- **WALL MATERIALS**
- **CEILING MATERIAL**
- **12X12 FLOOR TILE**

Sampling and Analysis

Asbestos bulk samples were collected and analyzed by Polarized Light Microscopy (PLM) with dispersion staining as described in the "Interim Method for the Determination of Asbestos in Bulk Insulation Samples", Method EPA-600/R-93/116 (Federal Register/Volume 40, CFR 763, Subpart F Appendix A, July 1993). Samples were analyzed by Environmental Science Services Laboratories, located in Lodi, CA.

Environmental Science Services

California/Nevada Operations

916.417.5361 209.304.8444

Email: envss1@aol.com

www.greenenvironmental1.com

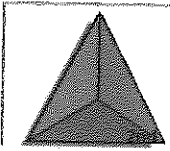

Environmental Science Services

Findings

For all samples collected within the present scope, laboratory analysis indicated:
PLM Analysis CVE Calibrated Visual Estimation Method EPA-600/R-93/116

Sample #	Material	Location	Type/% of Asbestos
1-2	WBJTC	THROUGHOUT INT.	<1% CHRYSOTILE
3-7	WALL TEXTURE	THROUGHOUT INT.	2% CHRYSOTILE
8-9	LINOLEUM	UPPER BATH	NAD
10-12	12X12 RFT	BATHROOMS	NAD
13-20	SAACM	INT. CEILING	12% CHRYSOTILE

NAD: NO ASBESTOS DETECTED

SAACM: SPRAY APPLIED ACOUSTIC CEILING MATERIAL

WBJTC: WALLBOARD JOINT TAPE COMPOUND COMPOSITE

Recommendations

Remove and dispose of all asbestos containing building materials in accordance with all Federal, State & Local regulations.

Limitations

Reasonable effort was made by ESS, Inc. personnel to locate and sample all accessible areas regarding the remediation. This report is intended to assist in the areas specified only. If any additional areas are to be impacted or that the scope of work is modified, additional investigation is advised.

Thank you for allowing Environmental Science Services to assist you with your asbestos consulting needs. Please feel free to contact us with any questions regarding this report at: (916) 417-5361.

Sincerely,

John Shane Jones, CAC, IH
California Certified Asbestos Consultant
CA DOSH #16-5690
Nevada DOSH # IJPM-20188
Senior Staff Hygienist
Environmental Science Services

Environmental Science Services

California/Nevada Operations

916.417.5361 209.304.8444

Email: envss1@aol.com

www.greenenvironmental1.com

Certificate of Analysis PLM Polarized Light Microscopy Asbestos Identification
 AIHA LABORATORY ID # 232274



ENVIRONMENTAL SCIENCE SERVICES
 Lab Report # 201085

Client:
 Environmental Science Services
 P. O. Box 452
 Lockeford, CA 95237
 916.417.5361

Date Collected: 02/21/20
Date Received: 02/21/20
Date Analyzed: 02/21/20

Project #: 20181085-1
Project Address: 1 Ralph Park
 Crocket, CA

Analytical Analysis Method: EPA-600 / R-93 / 116 and EPA 600 / M4-82 / 020

Lab/Client #	Material	Lab Attributes	Fibrous	Non-Fibrous	Asbestos%
1085-1	WBJTC Int Wall	Heterogeneous White/Tan Non-Fibrous Bound	10% Cellulose	%2 Paint %75 Gypsum %12 Binder	<1% Chrysotile Asbestos
1085-2	WBJTC Int Wall	Heterogeneous White/Tan Non-Fibrous Bound	10% Cellulose	%2 Paint %75 Gypsum %12 Binder	<1% Chrysotile Asbestos
1085-3	Texture Int Wall	Heterogeneous White/Tan Non-Fibrous Bound	8% Cellulose	%2 Paint %80 CaCO3 %8 Binder	2% Chrysotile Asbestos
1085-4	Texture Int Wall	Heterogeneous White/Tan Non-Fibrous Bound	8% Cellulose	%2 Paint %80 CaCO3 %8 Binder	2% Chrysotile Asbestos
1085-5	Texture Int Wall	Heterogeneous White/Tan Non-Fibrous Bound	8% Cellulose	%2 Paint %80 CaCO3 %8 Binder	2% Chrysotile Asbestos
1085-6	Texture Int Wall	Heterogeneous White/Tan Non-Fibrous Bound	8% Cellulose	%2 Paint %80 CaCO3 %8 Binder	2% Chrysotile Asbestos
1085-7	Texture Int Wall	Heterogeneous White/Tan Non-Fibrous Bound	8% Cellulose	%2 Paint %80 CaCO3 %8 Binder	2% Chrysotile Asbestos

Certificate of Analysis PLM Polarized Light Microscopy Asbestos Identification

AIHA LABORATORY ID # 232274

1085-8	Linoleum Upper Bath	Heterogeneous Non-Fibrous	20% Cellulose	%5 Paint %60 CaCO3 %15 Binder	NAD
1085-9	Linoleum Upper Bath	Heterogeneous Non-Fibrous	20% Cellulose	%5 Paint %60 CaCO3 %15 Binder	NAD
1085-10	12X12 Floor Tile	Homogeneous Multi Fibrous Bound	5% Fiberglass 10% Synthetic	%25 CaCO3 %60 Vinyl Bind.	None Detected
1085-11	12X12 Floor Tile	Homogeneous Multi Fibrous Bound	5% Fiberglass 10% Synthetic	%25 CaCO3 %60 Vinyl Bind.	None Detected
1085-12	12X12 Floor Tile	Homogeneous Multi Fibrous Bound	5% Fiberglass 10% Synthetic	%25 CaCO3 %60 Vinyl Bind.	None Detected
1085-13	Acoustic Ceiling	Heterogeneous White/Tan Non-Fibrous Bound	10% Cellulose	%2 Paint %60 Gypsum %10 Binder	12% Chrysotile Asbestos
1085-13	Acoustic Ceiling	Heterogeneous White/Tan Non-Fibrous Bound	10% Cellulose	%2 Paint %60 Gypsum %10 Binder	12% Chrysotile Asbestos
1085-13	Acoustic Ceiling	Heterogeneous White/Tan Non-Fibrous Bound	10% Cellulose	%2 Paint %60 Gypsum %10 Binder	12% Chrysotile Asbestos
1085-13	Acoustic Ceiling	Heterogeneous White/Tan Non-Fibrous Bound	10% Cellulose	%2 Paint %60 Gypsum %10 Binder	12% Chrysotile Asbestos
1085-13	Acoustic Ceiling	Heterogeneous White/Tan Non-Fibrous Bound	10% Cellulose	%2 Paint %60 Gypsum %10 Binder	12% Chrysotile Asbestos
1085-13	Acoustic Ceiling	Heterogeneous White/Tan Non-Fibrous Bound	10% Cellulose	%2 Paint %60 Gypsum %10 Binder	12% Chrysotile Asbestos
1085-13	Acoustic Ceiling	Heterogeneous White/Tan Non-Fibrous Bound	10% Cellulose	%2 Paint %60 Gypsum %10 Binder	12% Chrysotile Asbestos

Certificate of Analysis PLM Polarized Light Microscopy Asbestos Identification
 AIHA LABORATORY ID # 232274

Bound					
1085-13	Acoustic Ceiling	Heterogeneous White/Tan Non-Fibrous Bound	10% Cellulose	%2 Paint %60 Gypsum %10 Binder	12% Chrysotile Asbestos
1085-13	Acoustic Ceiling	Heterogeneous White/Tan Non-Fibrous Bound	10% Cellulose	%2 Paint %60 Gypsum %10 Binder	12% Chrysotile Asbestos

Supervisor 

Analyst 
 John S. Jones

Bulk Sample(s) submitted was (were) analyzed in accordance with the procedure outlined in the U S Federal Register 40 CFR 763, Subpart F, Appendix A: EPA-600/R-93/116 (Method for Determination of Asbestos in Building Materials), and EPA-600/M4-82-020 (US EPA Interim Method for the Determination of Asbestos in Insulation Samples). Samples were analyzed using Calibrated Visual Estimations (CVES); therefore, results may not be reliable for samples of low asbestos concentration levels. Samples of wall systems containing discrete and separable layers are analyzed separately and reported as composite unless specifically requested by the customer to report analytical results for individual layers. The report applies to only the items tested. Results are representative of the samples submitted and may not represent the entire material from which the samples were collected. "No Asbestos Detected" means that no asbestos was observed in the sample. "<1%" (less than one percent) means that asbestos was observed in the sample but the concentration is below the quantifiable level of 1%. Environmental Science Services participates in a proficiency analytical program with American Industrial Hygiene Association (AIHA) laboratory ID number 232274. This report may not be reproduced, except in full without the expressed written consent of Environmental Science Services.

Proposal#: P-056411
Proposal: 05/20/2020
Estimator: Peter Landre

SYNERGY ENTERPRISES

Phone: 510 259 - 1700
Fax: 510 259 - 1771
Toll Free: 800 439 - 9610

CA STATE LIC. #804759
 EPA #CAD982029258/#CAL000291177
 CA STATE LEAD
 ABATEMENT CERT #A0481
 OSHA REG #868



E-mail:
 p.landre@synergycompanies.org

28436 SATELLITE STREET, HAYWARD, CA 94545

Work Performed at: 1 Rolph Park Dr. Crockett, CA 94525	Billing Information: Crockett Community Services District P.O. Box 578 Crockett, CA 94525 Dale McDonald 510-787-2992 manager@town.crockett.ca.us	Owner Information: 1 Rolph Park Dr. Crockett, CA 94525
---	---	---

Scope of Work

SYNERGY will supply all labor, equipment, materials, services and permits to complete work as referenced herein in strict accordance with all current applicable Federal, State, and Local regulations, standards and codes governing asbestos abatement and any other work done in connection with the Scope of Work.

Work to be Performed	Total
Properly isolate and contain interior of building Place work area under HEPA filtered negative pressure differential Remove asbestos containing drywall from walls and ceiling throughout Remove asbestos containing acoustic spray from ceiling in living room, dining room, two bedrooms, blue office, waiting areas 1 and 2, entrance office, main office, and rear room HEPA vacuum work area Encapsulate work area Properly dispose of waste BAAQMD notification fee included	\$78,550.00
Remove asbestos containing acoustic spray from ceiling in living room, dining room, two bedrooms, blue office, waiting areas 1 and 2, entrance office, main office, and rear room HEPA vacuum work area Encapsulate work area Properly dispose of waste	\$8,450.00
Payments: Customer will pay a down payment of [0.00] to SYNERGY ENTERPRISES prior to scheduling work. The balance of the contract price of [87,000.00] will be due the day of the job is finished. PAYMENT MUST BE GIVEN TO FOREMAN AT JOB SITE UPON COMPLETION OF WORK. 1.5% per month will be due on any unpaid balance. Terms: [Net 30 Days]	\$87,000.00 TOTAL

Do not sign this agreement until you have read items 1-19 and important notices on the following 2 pages of document.

CUSTOMER x: _____ Date: _____

CONTRACTOR x: _____ Date: _____

WARRANTIES: SYNERGY guarantees and warrants that for a period of one year from the date of completion of the Scope of Work, it will replace or repair any work which is defective in workmanship or materials or which does not conform to the specifications set forth in the Scope of Work. This guarantee does not extend to the performance of any materials for other than those uses for which the material is intended. SYNERGY makes no other representations or warranties of any kind and expressly disclaims all implied warranties, including warranties or merchantability and fitness for a particular purpose. "you the buyer may cancel this transaction at any time prior to midnight or the third business day after the date of this transaction."
 (See Reverse Side)

WOOD DESTROYING PESTS & ORGANISMS INSPECTION REPORT

Street Address 1 Rolph Park Dr.	City Crockett	Zip 94525	Inspection Date 03-02-2020	Page Number 1 of 10
------------------------------------	------------------	--------------	-------------------------------	------------------------

 <p>MightyMite Termite Services 215 E. Hacienda Avenue Campbell, CA 95008 Phone: (888) 661-1003 Fax: (408) 377-3802 www.mightymitetermite.com Registration # PR6433</p>	Report # 0032576
--	------------------

Ordered By: Dale McDonald 1 Rolph Park Dr. Crockett, CA 94525 (510) 787-2992	Property Owner and/or Party of Interest Dale McDonald 1 Rolph Park Dr. Crockett, CA 94525 (510) 787-2992	Report sent to: Dale McDonald 1 Rolph Park Dr. Crockett, CA 94525 (510) 787-2992
---	---	---

COMPLETE REPORT:
 LIMITED REPORT:
 SUPPLEMENTAL REPORT:
 REINSPECTION REPORT:

General Description: Two Story, Commercial Building, Unfurnished and Unoccupied	Inspection Tag Posted: Garage
	Other Tags Posted: Yes

An inspection has been made of the structure(s) shown on the diagram in accordance with the Structural Pest Control Act. Detached porches, detached steps, detached decks and any other structures not on the diagram were not inspected.

Subterranean Termites
 Drywood Termites
 Fungus/Dryrot
 Other Findings
 Further Inspection

If any of the above boxes are checked, it indicates that there were visible problems in accessible areas. Read the report for details on checked items.

DIAGRAM NOT TO SCALE

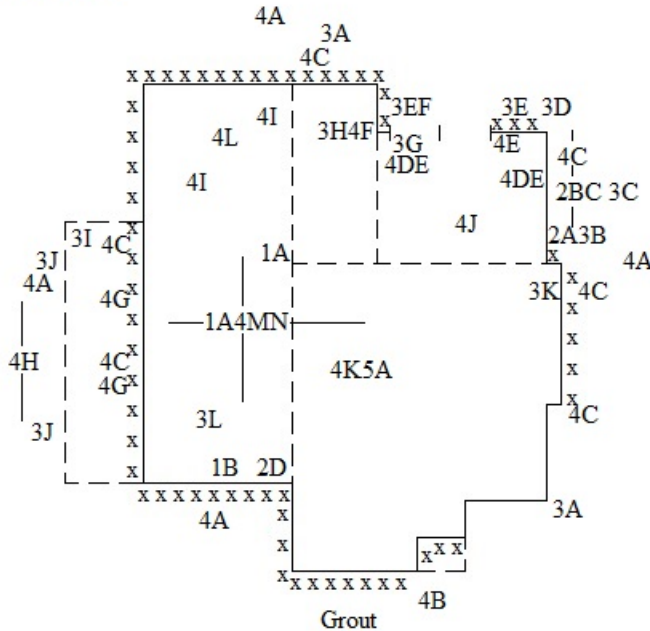

Inspected by: Erick Aguilar

State License #: FR 47756

Signature: 

You are entitled to obtain copies of all reports and completion notices on this property reported to the Structural Pest Control Board during the preceding two years. To obtain copies contact: Structural Pest Control Board, 20005 Evergreen Street, Suite 1500, Sacramento, California, 96815.

NOTE: Questions or problems concerning the above report should be directed to the manager of the company. Unresolved questions or problems with services performed may be directed to the Structural Pest Control Board at (916) 737-8188 or www.pestboard.ca.gov.

Wood Destroying Pests & Organisms Inspection Report

Street Address 1 Rolph Park Dr.	City Crockett	Zip 94525	Inspection Date 03-02-2020	Page Number 2 of 10
---	-------------------------	---------------------	--------------------------------------	-------------------------------

PLEASE READ THROUGH THIS ENTIRE DOCUMENT, IT EXPLAINS THE SCOPE AND LIMITATIONS OF A STRUCTURAL PEST CONTROL INSPECTION AND A WOOD DESTROYING AND ORGANISM INSPECTION REPORT.

This report, the work authorization contract, the Occupants Chemical and/or fumigation notice and any other attachments (if applicable) contain important information regarding the inspection, the inspection report, and any work that might be done by MightyMite Termite Services. Please call MightyMite Termite Services if you have any questions. If you have specific questions regarding an inspection usually the best person to answer those questions is the inspector who performs the inspection.

FUMIGATION INFORMATION - The following sections apply only if fumigation is recommended in this report.

1. If you wish to have fumigation performed please contact our office to schedule fumigation dates. Please plan ahead - (2-4 weeks)

Depending on our work load we may not be able to schedule fumigation on short notice. Once you have scheduled your fumigation you will receive an "Occupants Fumigation Notice" and "Fumigation Fact Sheet". These documents will explain the preparation work necessary for fumigation and should answer most questions regarding fumigation.

2.

It is required to have the Occupants Fumigation Notice and Contract signed and returned to our office at least 5 days prior to fumigation. The Occupants Fumigation Notice must be signed by the owner and all tenants or heads of household. It is the responsibility of the owner, agent or manager to provide all tenants with a copy of the Occupants Fumigation Notice and provide for notices to be signed and returned prior to fumigation.

3.

Fumigation against drywood termites requires all occupants to vacate the structure for at least 3 days (2 nights), unless the fumigation is started on a Friday or Saturday or for the purpose of wood boring beetle infestations which will require at least 5 days (4 nights).

4.

Fumigation may require preparation to accommodate the process. The price quoted is for fumigation of the main structure (unless otherwise noted) only and does NOT include any preparation work as needed for fumigation. Preparation work can be done at an additional cost by our fumigator or professional preparation company; however, arrangements must be made in advance. Preparation work may include, but is not limited to, the following: trim plants, trees, hedges, ground cover, etc. 12 inches away from the building; remove all potted and indoor plants including any plants under the roof overhang and patio cover, remove TV antennas, detach drain pipes and fences; remove any loose ground cover (bark, gravel, ivy, etc.). Once a fumigation date is scheduled specific preparation instructions will be issued.

Unless otherwise stated the fumigation price does not include any preparation work or turning on gas and relighting pilot lights. Our contract may include a separate price for preparation work. The owner/agent or responsible party should take steps as necessary to have preparation work done prior to fumigation and make an appointment with the gas company providing utility to turn on the gas and relight the pilot light.

5.

Reasonable care will be taken during the fumigation process to avoid damage to the roof, plants, landscaping, etc.; however, neither MightyMite Termite Services nor our fumigator (Driskell Fumigation) will assume any liability for incidental damage. Certain roof types or other special conditions which may be susceptible to damage may require additional release forms to be signed.

Wood Destroying Pests & Organisms Inspection Report

Street Address 1 Rolph Park Dr.	City Crockett	Zip 94525	Inspection Date 03-02-2020	Page Number 3 of 10
---	-------------------------	---------------------	--------------------------------------	-------------------------------

TERMS AND CONDITIONS REGARDING THIS REPORT

A.

A wood destroying pest and organism inspection report contains findings as to the presence or absence of evidence of wood destroying pests and organisms in visible and accessible areas and contains recommendations for correcting any infestations or infections found. The contents of wood destroying pest and organism inspection reports are governed by the Structural Pest Control Act and Rules and Regulations.

B.

NOTICE: REPORTS ON THIS STRUCTURE PREPARED BY VARIOUS REGISTERED COMPANIES SHOULD LIST THE SAME FINDINGS (I.E. TERMITE INFESTATIONS, TERMITE DAMAGE, FUNGUS DAMAGE, ETC.). HOWEVER, RECOMMENDATIONS TO CORRECT THESE FINDINGS MAY VARY FROM COMPANY TO COMPANY. YOU HAVE A RIGHT TO SEEK OPINION FROM ANOTHER COMPANY.

C.

WE GUARANTEE FUMIGATIONS DONE BY THIS COMPANY FOR TWO YEARS FROM THE DATE OF COMPLETION. FUMIGATIONS ARE GUARANTEED FOR TWO YEARS FROM THE DATE OF THE FUMIGATION BY THE SUBCONTRACTED COMPANY: DRISKELL FUMIGATION. WE CANNOT GUARANTEE WORK DONE BY THE OWNERS OR OWNERS' AGENT/CONTRACTOR. WE MAKE NO GUARANTEE AGAINST FUTURE INFESTATIONS/INFECTIONS, ADVERSE CONDITIONS/DAMAGE OR CONDITIONS/DAMAGE PRESENT BUT NOT EVIDENT AT THE TIME OF OUR INSPECTION. WE RESERVE THE RIGHT TO RETRACT BIDS AT ANY TIME PRIOR TO RECEIPT OF A SIGNED WORK AUTHORIZATION CONTRACT.

D.

The Structural Pest Control Act requires inspection of only those areas which are visible and accessible at the time of inspection. Some areas of the structure are not accessible to inspection, such as the interior of hollow walls, spaces between floor, areas concealed by carpeting, built-in appliances or cabinet work. Infestations or infections may be active in these areas without visible and accessible evidence. Areas that were not inspected are noted in the report. If you desire information about areas that were not inspected, a further inspection may be performed at an additional cost (to be determined on a case by case basis).

E.

Some structures do not comply with building code requirements or may have structural, plumbing, electrical, heating, air conditioning or other defects that do not pertain to wood destroying organisms. A wood destroying pest and organisms inspection report does not contain information on such defects, if any, as they are not within the scope of the licenses of either the inspector or the company issuing a wood destroying pest and organism report.

F.

MOLD DISCLAIMER: There may be health related issues associated with the findings reflected in this report. We are not qualified to and do not render an opinion concerning any such health issues. The inspection reflected by this report was limited to the visible and accessible areas only. Questions concerning health related issues, which may be associated with the findings or recommendations reflected in this report, the presence of mold, and the release of mold spores or concerning indoor air quality should be directed to a Certified Industrial Hygienist.

G.

Showers over finished ceilings are not water tested. Testing may cause damage to ceilings below the shower. Further inspection can be performed by opening the ceiling below the shower and performing a water test.

Wood Destroying Pests & Organisms Inspection Report

Street Address 1 Rolph Park Dr.	City Crockett	Zip 94525	Inspection Date 03-02-2020	Page Number 4 of 10
---	-------------------------	---------------------	--------------------------------------	-------------------------------

H.

Unless specifically noted, exterior inspection is a visual inspection from the ground level only.

Our inspectors do not access or directly inspect the roof or any portions of the structure (second floor walls and roof eaves). Portions of the structure that are only accessible for direct inspection from the roof are not included in the scope of this inspection. Interested parties may request further inspection at an additional cost (to be determined on a case by case basis).

I.

The exterior surface of the roof was not inspected. If you want the water tightness of the roof determined, you should contact a roofing contractor who is licensed by the Contractors' State License Board.

J.

Any structures not shown on the diagram are not included in the scope of this inspection. This includes, but is not limited to: fences, retaining walls, wooden planters, benches, gazebos, any wooden landscaping features, etc. Detached structures which are not shown on the diagram are not included in the scope of this inspection. This includes, but is not limited to: detached garages, decks, stairs, sheds, pool or guest houses, arbors, trellis, etc. Interested parties may request further inspection at an additional cost (to be determined on a case by case basis).

K.

MightyMite Termite Services does not guarantee any repair or treatment done by others.

L.

"NOTICE: The charge for service that this company subcontracts to another registered company may include the company's charges for arranging and administering such services that are in addition to the direct costs associated with paying the subcontractor. You may accept MightyMite Termite Services bid or you may contract with another registered company licensed to perform the work.

If you choose to contract directly with another registered company, MightyMite Termite Services will not in any way be responsible for any act or omission in the performance of work that you directly contract with another to perform."

M.

"State law requires that you be given the following information: CAUTION -PESTICIDES ARE TOXIC CHEMICALS. Structural Pest Control Companies are registered and regulated by the Structural Pest Control Board, and apply pesticides which are registered and approved for use by the California Department of Pesticide Regulation and the United States Environmental Protection Agency. Registration is granted when the state finds that, based on existing scientific evidence, there are no appreciable risks if proper use conditions are followed or that the risks are outweighed by the benefits. The degree of risk depends upon the degree of expose, so exposure should be minimized."

N.

"If within 24 hours following application you experience symptoms similar to common seasonal illness comparable to the flu (or other symptoms of products that MightyMite Termite Services may use during treatment (per individual labels): XT-2000 Plus - ; Termidor SC - in severe cases of overexposure by oral ingestion, lethargy, muscle tremors and in extreme cases, possibly convulsions may occur; Termidor Dry - in severe cases of overexposure by oral ingestion, lethargy, muscle tremors and in extreme cases, possibly convulsions may occur; Altriset - when used as directed this product does not present hazard to humans or domestic animals ; Tim-Bor - ; Premise Foam - if ingested have the person sip a glass of water if able to swallow and contact the poison control center or your doctor, do not induce vomiting unless instructed to so by the poison control center), contact your physician or poison control center (800-876-4766) and your pest control company immediately."

Wood Destroying Pests & Organisms Inspection Report

Street Address	City	Zip	Inspection Date	Page Number
1 Rolph Park Dr.	Crockett	94525	03-02-2020	5 of 10

O.

"For further information, contact any of the following: MightyMite Termite Services (888-661-1003); for Health Questions-the County Health Department: Santa Clara County (408-885-4214); Alameda County (510-267-8000); Contra Costa County (925-313-6712); Marin County (415-499-3030); Monterey County (831-755-4500); Santa Cruz County (831-454-4000); San Francisco County (415-554-2500); San Mateo County (650-573-2346). For Application Information - the County Agricultural Commissioner: Santa Clara County (408-918-4600); Alameda County (510-670-5232); Contra Costa County (925-646-5250); Marin County (415-473-6700); Monterey County (831-759-7325); Santa Cruz County (831-763-8080); San Francisco County (415-252-3830); San Mateo County (650-363-4700). For Regulatory Information - the Structural Pest Control Board (916-561-8700) at 2005 Evergreen Street #1500, Sacramento, CA 95815."

P.

"Local treatment is not intended to be an entire structure treatment method. If infestations of wood-destroying pests extend or exist beyond the area(s) of local treatment, they may not be exterminated."

Q.

This company will use caution and due diligence in their operations, but assumes no responsibility for any damage to pipes, electrical wires or any other object that is damaged while drilling through concrete slab, walkways, porches, steps, tile, stone or brick. Reasonable care will be taken during treatment work to avoid damage to plants; some damage, however, may be unavoidable. MightyMite Termite Services will not assume any liability for any damage to plant life.

R.

An estimate for treatment will be given unless the client or their agent instructs otherwise. As contractor's prices may vary depending on a variety of things, including proposed methods of correction and changing material costs. A list of contractors can be provided with each report upon request.

S.

"This company will re-inspect repairs done by others within four months (120 days) of the original inspection. A charge, if any, can be no greater than the original inspection fee for each re-inspection. The re-inspection is a visual inspection and if inspection of concealed areas is desired, inspection of work in progress will be necessary. Any guarantees must be received from the parties performing the repairs."

GUARANTEES & WARRANTIES

NOTE:This company guarantees treatments applied by this company only for a period of **TWO YEARS**. This guarantee applies to the **ENTIRE STRUCTURE** for the control of **DRYWOOD AND SUBTERRANEAN** termites only, with the exception of any areas that were not permitted to be inspected by the owner, tenant or property manager at time of inspection. Areas that require further inspection, but that the owner granted access to at time of inspection, such as those blocked by duct work, lack of clearance, personal storage for example, will still be covered under the warranty as normal. Should re-infestation occur within this period, this company will retreat at no additional charge; however, this firm cannot be held responsible for termite damage that has occurred in any visible areas or in the enclosed and inaccessible areas as it would be impossible to determine how much damage was concealed prior to our treatment.

Wood Destroying Pests & Organisms Inspection Report

Street Address 1 Rolph Park Dr.	City Crockett	Zip 94525	Inspection Date 03-02-2020	Page Number 6 of 10
---	-------------------------	---------------------	--------------------------------------	-------------------------------

(1) Subterranean Termite Findings

	Description
1A	<p>FINDING: Subterranean termite infested cellulose debris was found in the SUBAREA.</p> <p>RECOMMENDATION: We recommend removal of all cellulose debris of a size that can be raked and larger. Chemically treat the interior and/or exterior perimeter of the foundation with Termidor SC (Active Ingredient: Fipronil) or Termidor HE (Active Ingredient: Fipronil) or Altriset (Active Ingredient: Chlorantraniliprole) according to label instructions, which would include drilling of any concrete slabs or porches.</p> <p>PLEASE NOTE: If concrete drilling is included or prescribed by the inspector as a part of your subterranean termite treatment, the hammer drills that are used to drill the concrete do draw 120 volts of power while in use. If your home has an older/insufficient electrical panel, please be advised to turn off any large appliances you may have running during the treatment process as the hammer drill does draw a significant amount of volts/amperage when in use.</p> <p style="text-align: center;">***INTERIOR & EXTERIOR SOIL TREATMENT - DRILL AT X'S***</p>
1B	<p>FINDING: Evidence of old, inactive infestation of subterranean termites were found in the SUBAREA FRAMING.</p> <p>RECOMMENDATION: As this finding appears inactive at this time, there is no recommendation for treatment at this time. We recommend this condition be routinely monitored to prevent any future infestation or possible damage by a Branch 3 structural pest control company.</p>

(2) Drywood Termite Findings

	Description
2A	<p>FINDING: Evidence of drywood termite infestation was noted in the GARAGE SIDE DOOR TRIM AND FRAMING.</p> <p>RECOMMENDATION: Drill and treat the infested wood with XT-2000 Plus (Active Ingredient: D-Limonene) and/or Termidor Dry (Active Ingredient: Fipronil) and/or Premise Foam (Active Ingredient : Imidacloprid) and/or Termidor Foam (Active Ingredient: Fipronil) as prescribed per the label instructions. Remove or mask visible and accessible drywood termite pellets in the area using mortar.</p>
2B	<p>FINDING: Evidence of drywood termite infestation was noted in the BALCONY TRIM.</p> <p>RECOMMENDATION: Drill and treat the infested wood with XT-2000 Plus (Active Ingredient: D-Limonene) and/or Termidor Dry (Active Ingredient: Fipronil) and/or Premise Foam (Active Ingredient : Imidacloprid) and/or Termidor Foam (Active Ingredient: Fipronil) as prescribed per the label instructions. Remove or mask visible and accessible drywood termite pellets in the area using mortar.</p>
2C	<p>FINDING: Evidence of drywood termite damage noted to the BALCONY TRIM.</p> <p>RECOMMENDATION: Owner or owners' contractor to remove and replace all damaged wood members as necessary. If, during the course of repairs damage is found to extend into previously inaccessible areas, contact MightyMite Termite Services so that a supplemental report can be issued with additional findings for further corrections or repairs.</p>
2D	<p>FINDING: Evidence of drywood termite infestation was noted in the SUBAREA FRAMING.</p> <p>RECOMMENDATION: Drill and treat the infested wood with XT-2000 Plus (Active Ingredient: D-Limonene) and/or Termidor Dry (Active Ingredient: Fipronil) and/or Premise Foam (Active Ingredient : Imidacloprid) and/or Termidor Foam (Active Ingredient: Fipronil)</p>

Wood Destroying Pests & Organisms Inspection Report

Street Address 1 Rolph Park Dr.	City Crockett	Zip 94525	Inspection Date 03-02-2020	Page Number 7 of 10
---	-------------------------	---------------------	--------------------------------------	-------------------------------

	as prescribed per the label instructions. Remove or mask visible and accessible drywood termite pellets in the area using mortar.
--	---

(3) Fungus/Dryrot Findings

	Description
3A	<p>FINDING: There is evidence of fungus dryrot damage noted to the FASCIA due to LACK OF SEALANT.</p> <p>RECOMMENDATION: Owner or owners' contractor to remove and replace all damaged wood as needed and treating the adjacent wood with an anti-fungicide (copper naphthenate - a wood preservative) and prime paint the wood. If, during the course of repairs damage is found to extend into previously inaccessible areas, contact MightyMite Termite Services and a supplemental report will be issued with additional findings and recommendations for further repairs.</p>
3B	<p>FINDING: There is evidence of fungus dryrot damage noted to the GARAGE SIDE DOOR JAMB due to LACK OF SEALANT.</p> <p>RECOMMENDATION: Owner or owners' contractor to remove and replace all damaged wood as needed and treating the adjacent wood with an anti-fungicide (copper naphthenate - a wood preservative) and prime paint the wood. If, during the course of repairs damage is found to extend into previously inaccessible areas, contact MightyMite Termite Services and a supplemental report will be issued with additional findings and recommendations for further repairs.</p>
3C	<p>FINDING: There is evidence of fungus dryrot damage noted to the BALCONY TRIM due to LACK OF SEALANT.</p> <p>RECOMMENDATION: Owner or owners' contractor to remove and replace all damaged wood as needed and treating the adjacent wood with an anti-fungicide (copper naphthenate - a wood preservative) and prime paint the wood. If, during the course of repairs damage is found to extend into previously inaccessible areas, contact MightyMite Termite Services and a supplemental report will be issued with additional findings and recommendations for further repairs.</p>
3D	<p>FINDING: There is evidence of fungus dryrot damage noted to the CORNER TRIM due to LACK OF SEALANT.</p> <p>RECOMMENDATION: Owner or owners' contractor to remove and replace all damaged wood as needed and treating the adjacent wood with an anti-fungicide (copper naphthenate - a wood preservative) and prime paint the wood. If, during the course of repairs damage is found to extend into previously inaccessible areas, contact MightyMite Termite Services and a supplemental report will be issued with additional findings and recommendations for further repairs.</p>
3E	<p>FINDING: There is evidence of fungus dryrot damage noted to the SIDING AND TRIM due to LACK OF SEALANT.</p> <p>RECOMMENDATION: Owner or owners' contractor to remove and replace all damaged wood as needed and treating the adjacent wood with an anti-fungicide (copper naphthenate - a wood preservative) and prime paint the wood. If, during the course of repairs damage is found to extend into previously inaccessible areas, contact MightyMite Termite Services and a supplemental report will be issued with additional findings and recommendations for further repairs.</p>

Wood Destroying Pests & Organisms Inspection Report

Street Address 1 Rolph Park Dr.	City Crockett	Zip 94525	Inspection Date 03-02-2020	Page Number 8 of 10
---	-------------------------	---------------------	--------------------------------------	-------------------------------

3F	<p>FINDING: There is evidence of fungus dryrot damage noted to the GARAGE DOOR TRIM AND JAMB due to LACK OF SEALANT.</p> <p>RECOMMENDATION: Owner or owners' contractor to remove and replace all damaged wood as needed and treating the adjacent wood with an anti-fungicide (copper naphthenate - a wood preservative) and prime paint the wood. If, during the course of repairs damage is found to extend into previously inaccessible areas, contact MightyMite Termite Services and a supplemental report will be issued with additional findings and recommendations for further repairs.</p>
3G	<p>FINDING: There is evidence of fungus dryrot damage noted to the GARAGE EXPOSED CEILING FRAME due to LACK OF SEALANT.</p> <p>RECOMMENDATION: Owner or owners' contractor to remove and replace all damaged wood as needed and treating the adjacent wood with an anti-fungicide (copper naphthenate - a wood preservative) and prime paint the wood. If, during the course of repairs damage is found to extend into previously inaccessible areas, contact MightyMite Termite Services and a supplemental report will be issued with additional findings and recommendations for further repairs.</p>
3H	<p>FINDING: There is evidence of fungus dryrot damage noted to the CHEMICAL ROOM EXPOSED CEILING FRAME due to LACK OF SEALANT.</p> <p>RECOMMENDATION: Owner or owners' contractor to remove and replace all damaged wood as needed and treating the adjacent wood with an anti-fungicide (copper naphthenate - a wood preservative) and prime paint the wood. If, during the course of repairs damage is found to extend into previously inaccessible areas, contact MightyMite Termite Services and a supplemental report will be issued with additional findings and recommendations for further repairs.</p>
3I	<p>FINDING: There is evidence of fungus dryrot damage noted to the OVERHANG TONGUE AND GROOVE BOARDS due to LACK OF SEALANT.</p> <p>RECOMMENDATION: Owner or owners' contractor to remove and replace all damaged wood as needed and treating the adjacent wood with an anti-fungicide (copper naphthenate - a wood preservative) and prime paint the wood. If, during the course of repairs damage is found to extend into previously inaccessible areas, contact MightyMite Termite Services and a supplemental report will be issued with additional findings and recommendations for further repairs.</p>
3J	<p>FINDING: There is evidence of fungus dryrot damage noted to the OVERHANG FASCIA due to LACK OF SEALANT.</p> <p>RECOMMENDATION: Owner or owners' contractor to remove and replace all damaged wood as needed and treating the adjacent wood with an anti-fungicide (copper naphthenate - a wood preservative) and prime paint the wood. If, during the course of repairs damage is found to extend into previously inaccessible areas, contact MightyMite Termite Services and a supplemental report will be issued with additional findings and recommendations for further repairs.</p>
3K	<p>FINDING: There is evidence of fungus dryrot damage noted to the SIDE DOOR AND JAMB due to LACK OF SEALANT.</p> <p>RECOMMENDATION: Owner or owners' contractor to remove and replace all damaged wood as needed and treating the adjacent wood with an anti-fungicide (copper naphthenate - a wood preservative) and prime paint the wood. If, during the course of repairs damage is found to extend into previously inaccessible areas, contact MightyMite Termite Services and a</p>

Wood Destroying Pests & Organisms Inspection Report

Street Address 1 Rolph Park Dr.	City Crockett	Zip 94525	Inspection Date 03-02-2020	Page Number 9 of 10
---	-------------------------	---------------------	--------------------------------------	-------------------------------

	supplemental report will be issued with additional findings and recommendations for further repairs.
3L	<p>FINDING: There is evidence of fungus dryrot damage noted to the SECOND STORY FASCIA AND TRIM due to LACK OF SEALANT.</p> <p>RECOMMENDATION: Owner or owners' contractor to remove and replace all damaged wood as needed and treating the adjacent wood with an anti-fungicide (copper naphthenate - a wood preservative) and prime paint the wood. If, during the course of repairs damage is found to extend into previously inaccessible areas, contact MightyMite Termite Services and a supplemental report will be issued with additional findings and recommendations for further repairs.</p>

(4) Other Findings

	Description
4A	<p>FINDING: The stucco siding at the perimeter of the home extends below the soil level thereby preventing a visual inspection of the foundation wall. No damage was noted (other than what may have been previously noted); however, this condition presents a potential hidden passage for subterranean termite infestation(s) through the void between the stucco siding and the foundation wall.</p> <p>RECOMMENDATION: Owner or owners' contractor to grade the soil away to remove any earth contact and limit the exposure to possible subterranean termite infestation(s).</p>
4B	<p>FINDING: The brick facade at the perimeter of the home extends below the soil level thereby preventing a visual inspection of the foundation. No damage was noted (other than what may have been previously noted); however, this condition presents a potential hidden passage for subterranean termite infestation through the void between the brick facade and the foundation.</p> <p>RECOMMENDATION: Owner or owners' contractor to grade the soil away to remove any earth contact and limited exposure to ground based wood destroying organisms.</p>
4C	<p>FINDING: There are cracks and/or damaged stucco at the areas indicated which could permit the infiltration of moisture into the wall voids.</p> <p>RECOMMENDATION: Owner or owners' contractor to seal/repair cracked and/or damaged areas to maintain a watertight seal.</p>
4D	<p>FINDING: Water damage was noted to GARAGE CEILING AND WALLS.</p> <p>RECOMMENDATION: Owner or owners' contractor to remove and replace the water damaged wood or trim.</p>
4E	<p>FINDING: The sheetrock/drywall is damaged at the GARAGE CEILING AND WALLS.</p> <p>RECOMMENDATION: Owner or owners' contractor to repair the damaged areas.</p>
4F	<p>FINDING: Water damage was noted to CHEMICAL ROOM CEILING. RECOMMENDATION: Owner or owners' contractor to remove and replace the water damaged wood or trim.</p>
4G	<p>FINDING: Evidence of infestation by carpenter bees were found in the OVERHANG FRAMING.</p> <p>RECOMMENDATION: Owner or owners' contractor to contact a General Pest Control Service</p>

Wood Destroying Pests & Organisms Inspection Report

Street Address 1 Rolph Park Dr.	City Crockett	Zip 94525	Inspection Date 03-02-2020	Page Number 10 of 10
---	-------------------------	---------------------	--------------------------------------	--------------------------------

	for treatment. Then the owner or owner's contractor is to patch or remove and replace the damage.
4H	FINDING: The gutters and downspouts were corroded/leaking or missing. RECOMMENDATION: Owner or owners' contractor to install new gutters and downspouts as needed.
4I	FINDING: The sheetrock/drywall is damaged at the ELECTRICAL PANEL ROOM CEILING AND WALLS. RECOMMENDATION: Owner or owners' contractor to repair the damaged areas.
4J	FINDING: There is loose and missing grout at the SECOND STORY UNIT HALL BATHROOM. There is no longer a watertight seal in this area. RECOMMENDATION: Owner or owners' contractor to caulk and/or grout all seams to prevent moisture infiltration.
4K	FINDING: The attic area contains significant exposed wood that is conducive of infestation by wood destroying organisms. RECOMMENDATION: Treat the exposed wood with Tim-Bor or BoraCare (Active Ingredient: Disodium Octaborate Tetrahydrate) to prevent future infestations. ***BORACARE***
4L	FINDING: There are stored articles in the subarea that contain cellulose material which can attract a variety of wood destroying pests and organisms. RECOMMENDATION: Owner or owners' contractor to remove these articles or store on a heavy duty sheet of plastic.
4M	FINDING: Cellulose debris was found in the crawl space area. RECOMMENDATION: Owner or owners' contractor to remove from the subarea all excessive cellulose debris in earth contact that is of a size that can be raked or larger. This excludes shavings or other cellulose too small to be raked or stored goods not in earth contact. Stumps and wood embedded in footings in earth contact shall be treated with a wood preservative if removal is impractical.
4N	FINDING: The subarea area contains significant exposed wood that is conducive of infestation by wood destroying organisms. RECOMMENDATION: Treat the exposed wood with Tim-Bor or BoraCare (Active Ingredient: Disodium Octaborate Tetrahydrate) to prevent future infestations. ***BORACARE***

(5) Further Inspection Findings

	Description
5A	The insulation in the attic area limits our inspection to the visible and accessible portions of these areas.

WORK AUTHORIZATION CONTRACT

Street Address 1 Rolph Park Dr.	City Crockett	Zip 94525	Inspection Date 03-02-2020	Page Number 1 of 2
------------------------------------	------------------	--------------	-------------------------------	-----------------------

 MightyMite Termite Services 215 E. Hacienda Avenue Campbell, CA 95008 Phone: (888) 661-1003 Fax: (408) 377-3802 www.mightymitetermite.com Registration # PR6433	Report # 0032576
---	------------------

Itemized Cost Breakdown (refer to items on report)

Treatment Bid Items	
1A / 2A / 2B / 2D	\$3,950.00
Treatment Bid Total:	\$3,950.00

Optional Bid Items	
4K	\$500.00
4M	\$200.00
4N	\$500.00
Optional Bid Total	\$1,200.00

*****PLEASE NOTE THAT THE PRICE ON THIS CONTRACT IS THE FINAL PRICE AND THAT ALL APPLICABLE DISCOUNTS HAVE ALREADY BEEN APPLIED*****

THIS IS A BINDING CONTRACT between our company and Dale McDonald, and incorporates our termite report # 0032576 dated 03-02-2020 for real property located at 1 Rolph Park Dr., Crockett, CA 94525. Items on the report may contain provisions for additional costs over and above the original estimate. Please read the report carefully and completely.

FOR WARRANTY INFORMATION, PLEASE SEE THE BOTTOM OF PAGE 5 OR TOP OF PAGE 6 OF YOUR INSPECTION REPORT #0032576.

CONDITIONS:

1. This offer is limited to 4 months from the date of the report.
2. If further inspection is recommended, or if additional work is required, we will provide prices or recommendations for correction. Interested parties will be notified prior to any work being done.
3. Payment is due in full on the date of the work being completed, unless prior arrangements have been made. If payment is not received upon work being completed, a 1.5% interest charge will be added for every 30 days payment is past due.
4. Notice to owner of Mechanic's Lien as required by the Structural Pest Control Board: Under the California Mechanics Lien Law, any structural pest control operator who contracts to do work for you, any contractor, subcontractor, laborer, supplier or other person who helps to improve your property, but is not paid for his work or supplies, has a right to enforce a claim against your property. This means that after a court hearing, your property could be sold by a court officer and the proceeds of the sale used to satisfy the indebtedness. This can happen even if you have paid your contractor in full if the subcontractor, laborers or suppliers remain unpaid. To preserve their right to file a claim or lien against your property, certain claimants such as subcontractors or material suppliers are required to provide you with a document entitled "Preliminary Notice". General contractors and laborers for wages do not have to provide this notice. A Preliminary Notice is not a lien against your property. Its purpose is to notify you of persons who may have a right to file a lien against your property if they are not paid.

MIGHTYMITE TERMITE SERVICES

WORK AUTHORIZATION CONTRACT

Street Address 1 Rolph Park Dr.	City Crockett	Zip 94525	Inspection Date 03-02-2020	Page Number 2 of 2
---	-------------------------	---------------------	--------------------------------------	------------------------------

5. We will use due caution and diligence in their operations and care will always be taken to minimize any damage, but assumes no responsibility for matching existing colors and styles, or for incidental damage to roof coverings, TV antennas, solar panels, rain gutters, plant life, paint or wall coverings. There may be health related issues associated with the structural repairs reflected in the inspection report referenced by this work authorization contract. These health issues include but are not limited to the possible release of mold spores during the course of repairs. We are not qualified to and do not render any opinion concerning such health issues or any special precautions. Any questions concerning health issues or any special precautions to be taken prior to or during the course of such repairs should be directed to a Certified Industrial Hygienist before any such repairs are undertaken. By executing this work authorization contract, customer acknowledges that he or she has been advised of the foregoing and has had the opportunity to consult with a qualified professional.

6. This report is limited to the accessible areas of the structure shown on the diagram. Please refer to the report for areas not inspected and further information.

7. TERMITE TREATMENT TERMS OF PAYMENT. We agree to pay the sum of _____ upon the completion of work on the day of treatment, unless prior arrangements have been made.

8. CONSTRUCTION REPAIR TERMS OF PAYMENT. We agree to pay 30% of the sum of _____ prior to the start of the work, an additional 30% of the sum during the middle of the work and the balance of the sum on the day of completion of the work.

9. CONSTRUCTION REPAIR (ONLY) TERMS OF PAYMENT BREAKDOWN:

First 30% payment amount: _____

Halfway 30% payment amount: _____

Balance due upon completion amount: _____

10. We authorize this company to perform items

_____ for a contract price of

_____.

SIGNED _____ DATE _____

_____ DATE _____ OWNER OR OWNER'S AGENT
(if authorizing party is not owner of said property)

OWNER OR OWNER'S AGENT (PRINT NAME)

It is assumed that if an agent orders work on the owner's behalf, and that they were notified prior by said agent, that if payment is not made by the agent it will be the responsibility of the owner to produce payment.